

# User Guide

Dreamer Desktop 3D Printer

**FLASHFORGE**



# FLASHFORGE 3D PRINTER

*Create a Joyful 3D Life with You!*

# CONTENTS

---

## **WELCOME TO FLASHFORGE DREAMER**

- A. How to use this manual
- B. The FlashForge Experience and Promise
- C. Understanding 3D Printing in 3 Minutes

## **Chapter 1. SETTING UP THE DREAMER**

- A. Getting to know your Dreamer
- B. Unboxing the Dreamer
- C. Hardware assembly
  - C1. Changing voltage on Dreamer power supply
  - C2. Mounting the extruder set
  - C3. Installing filament
  - C4. Plugging in power cord & USB cable
- D. Loading/unloading filament
  - D1. Loading filament
  - D2. Unloading filament
- E. Leveling the build plate

## **Chapter 2. A THOROUGH LOOK AT THE FLASHPRINT SOFTWARE**

- A. Overview of the functions

## **Chapter 3. MAKING YOUR FIRST PRINT**

- A. Overview
- B. Single & dual-extrusion print
  - B1. Single-extrusion print
  - B2. Dual-extrusion print
- C. Methods of printing
  - C1. Printing from USB
  - C2. Printing from SD card
  - C3. Printing from Wi-Fi
  - C4. Printing with support

## **Chapter 4. ADDITIONAL INFORMATION**

- A. Getting support

# WELCOME TO FLASHFORGE DREAMER

**A. How to use this manual**

**B. The FlashForge Experience & Promise**

**C. The 3D printing process**

# A. How to use this manual

---

This user manual is divided into four chapters for ease of navigation and will use examples based on Microsoft Windows 7 operating system. The first chapter lays out the guide on setting up the Dreamer and preparing for its first print. You will learn the ins and outs of FlashPrint software in the second chapter. The third portion is the actual printing and covers the procedures for various methods of printing and techniques. The last chapter includes information regarding obtaining support.

## **PRECAUTION:**

Prior to powering on the Dreamer, make sure the power supply switch is set to 115V if you are located in the United States and Canada. For other countries, please refer to your country's AC output voltage. Failure to do so will damage the mainboard. For instructions on how to do this, please refer to page 14.

## **Please make sure to read this section carefully prior to setting up and operating the Dreamer.**

- The Dreamer is very sensitive to static electricity, so please make sure you contact a grounded object before operating the machine.
- Before repairing or making any alterations to the Dreamer, it is essential that the machine is turned off, and the power cord is unplugged.
- The Dreamer operates at a very high temperature; allow the nozzle, extruded plastic and heating plate to cool before touching.
- Certain types of plastic filament may give off a slight odor when heated. Because of this, the Dreamer should always operate in a well-ventilated area.
- Do not leave the Dreamer unattended when in operation.

# B. The Flashforge Experience and Promise

---

## **The Flashforge Experience**

Congratulations on your purchase of the Flashforge Dreamer 3D desktop printer. You may already had prior experience with other Flashforge products or know the technology behind 3D printing. However, we still recommend that you read this manual as it contains important information helpful to getting the best experience out of the Dreamer. By following the user manual thoroughly and correctly, you will be able to make your first print in no time. If you'd like to go over the fundamentals of 3D printing and how it works, please read page 7.

## **The Flashforge Promise**

Our team is composed of geeks and makers who are passionate about 3D printing and want to share this new technology with the world. We understand the importance of product and service support, especially the challenges that a new technology may bring along. With FLASHFORGE, you can always expect a close, personal service from our team of experts.

At FLASHFORGE, we understand that 3D printing is a new technology to many individuals. Our aim is to educate and guide you through the entire process of 3D printing. With 3D printing, there are no limits — you can go as far as your imagination takes you. With the Dreamer, dreams are no longer simply just imaginations. They can become physical realities that you can hold, touch, and feel. It is amazing to see a 3D printer turn an idea into real life, layer by layer, and we are delighted to have you on-board with us to experience this phenomenon!

# C. Understanding 3D Printing in 3 Minutes

---

## What is 3D Printing?

Simply put, 3D printing is transforming three-dimensional models into physical objects that you can hold and touch. It is also called additive manufacturing because the 3D model is created by “adding” layers upon layers of material until the object is fully formed.

## The Technique

Fused filament fabrication is the most common method of 3D printing. It is also the method that the Dreamer uses. It works by melting plastic material called filament onto a print surface using high temperature. The filament solidifies after it cools down, which happens instantaneously after it is extruded from the print head. 3D objects are formed with the filament laying down multiple layers.

## 3D Printing Process

3D printing involves three steps: 1.) 3D model design, 2.) Slicing and exporting the 3D model, and 3.) Making the print

1. **Designing the 3D Model:** Currently, there are three ways of creating a 3D model.

*Designing From Scratch.* You can use free CAD (computer aided design) software such as Google Sketchup, Tinkercad, and Blender to design your very own 3D model. Or grab a copy of one of the commercial 3D design software such as AutoCAD, Maya, or Rhino3D.

*3D Scanners.* An alternative method to creating a 3D model is to scan an object. 3D scanners work by digitizing a physical object, collecting its geometric data, and saving it to a file on your PC. There are also apps that can turn a mobile device into a 3D scanner.

---

From the *Cloud*. The most popular way of obtaining a 3D model is to download it from websites that allow users to upload 3D models that they designed.

## **2. Slicing and Exporting the 3D Model:**

A slicing software is required to process and interpret the 3D model into the language that 3D printers can understand. The FlashPrint is the slicing software used for the FlashForge Dreamer.

FlashPrint will slice the 3D model into numerous layers and output it as a .g file, which is the format read by the Dreamer. The file is then transferred to the Dreamer by USB cable, SD card, or Wi-Fi.

## **3. Making the Print:**

Once the output file has been transferred to the Dreamer, it will start to turn the 3D model into a physical object by laying down layers of filament.



# Chapter 1.

# **SETTING UP THE DREAMER**

- A. Unboxing the Dreamer**
- B. Getting to know your Dreamer**
- C. Hardware assembly**
- D. Loading/unloading filament**
- E. Leveling the build plate**

# A. Unboxing the Dreamer

---

Congratulations on your purchase of the Flashforge Dreamer 3D printer! In about 15 minutes, you will be ready to start making your first 3D object. This section lays out the procedure for correctly removing the Dreamer from its shipping box. The Dreamer contains delicate components; please remember to handle with extra care and attention. Let's begin!

1. Put Dreamer package on the clean, tidy workbench, using a knife to cut the tape, then you can see two quick start guide, which will guide you know our Dreamer 3D Printer.



2. Remove the top protective foam pieces, which also houses the Dreamer's lid. Set this aside for now. The Dreamer unit will then be exposed.



3. Lift the Dreamer by its side openings and place it on a flat surface. You will then see the **Expert Kit**, **power cord**, and **USB 2.0 cable** in the shipping box.



---

4. The Dreamer will have an accessory box on top of it, which will house the extruder set. Remove the box and the foam pad from the Dreamer, and gently lay the extruder set on the Dreamer build plate.

Inside the accessory box, you will find an **SD card**, a **side fan duct**, and **two pieces of removable side panels**.

5. There are **two Build sheets** and **one leveling sheet** used for printing and leveling.



---

6. Hold the sides of the build plate as shown in the illustration, and lift up slowly until it is at the top.



7. You will see one **ABS** and one **PLA filament roll** and **two filament spool holder** under the build plate once it is moved out of the way.



8. Unboxing has been completed. The illustration to the right includes all the accessories that is included with the Dreamer.



# B. Getting to know your Dreamer

## Main view:

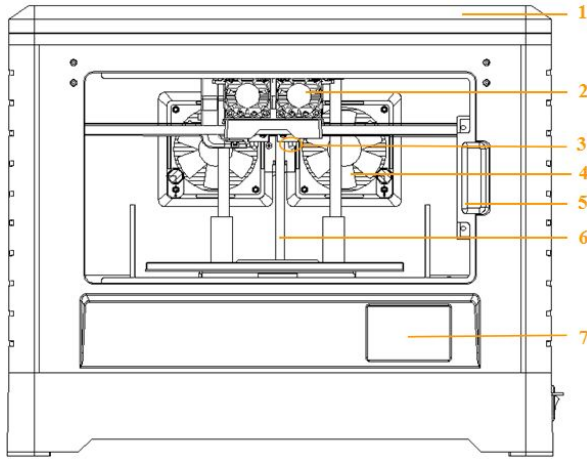

## Top view:

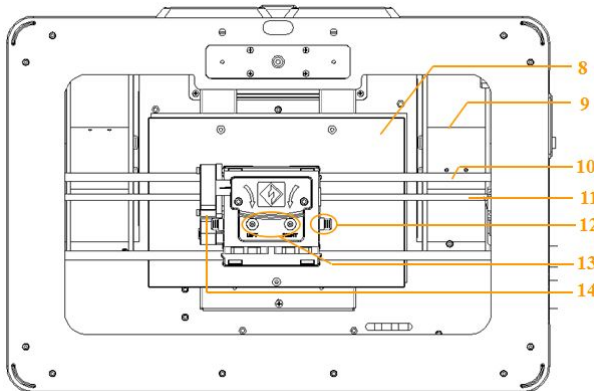

## Left view:

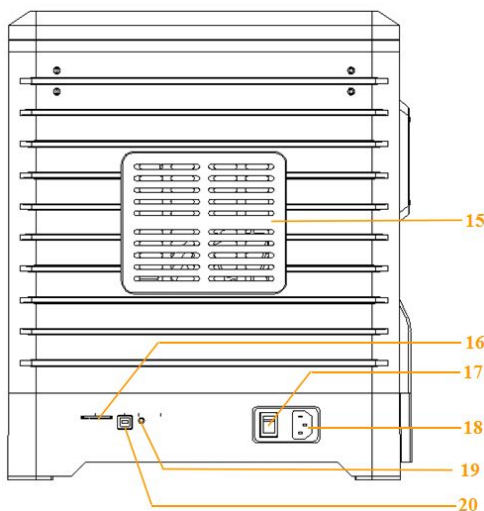

1. Top cover
2. Extruder fan
3. Nozzle
4. Ventilating fan
5. Front door
6. Z axis guide
7. Touch screen
8. Build plate
9. Filament
10. X axis guide
11. Belt
12. Spring strip
13. Extruder intake
14. Turbo fan
15. Vent
16. SD card input
17. Power switch
18. Power input
19. Reset button
20. USB input



ABS and PLA filament(2)

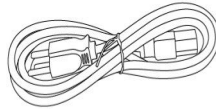

Power Cord



USB Cord

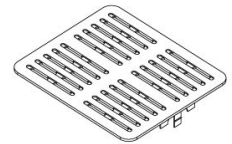

Vent(2)

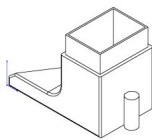

Fan Baffle Cap



Kit Box



Build Sheet



Quick State Guide

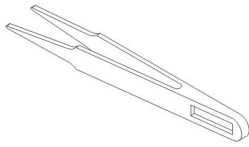

Tweezers

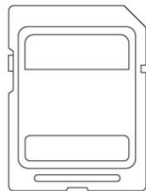

SD Card



Leveling Sheet



Screwdriver



Scraper

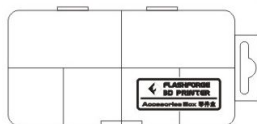

Screw Box



Carving Knife

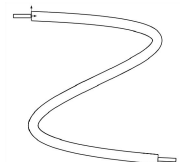

Sensor line

## C. Hardware Assembly

The Dreamer comes pre-assembled and is almost ready-to-print (ARP). All you need to do is set the appropriate voltage, mount the extruder set, and install the filament. It will only take between 5 to 10 minutes before you can fire up the Dreamer and prepare for your first 3D print!

### PRECAUTION:

FlashForge Dreamer uses a switching power supply with 115V/230V. Prior to installing the hardware, it is critical to check the AC output voltage of your home or workplace. The power supply should be switched to reflect your AC output voltage. Failure to do so will cause severe damage to the Dreamer. Please follow the steps below to switch to the correct voltage.

For the United States and Canada, the correct voltage to use is 115V. For most European countries, use 230V. **Please double-check as FLASHFORGE will not be responsible for damages as a result of improper care.**

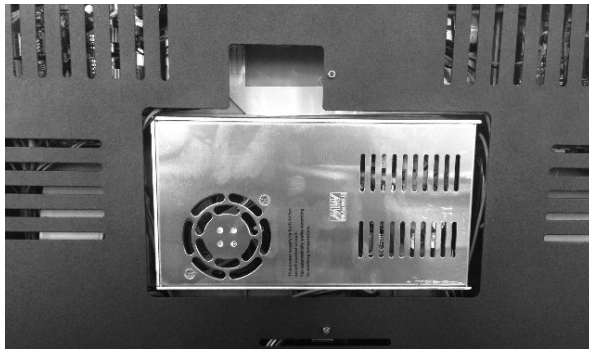

---

## Mounting the Extruder Set

1. Lay the extruder set on top of the extruder seat with the two extruder fans facing the front.

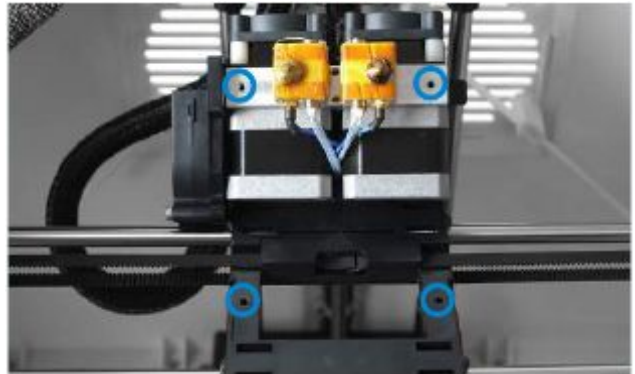

2. Secure the extruder set onto the extruder seat by using two M3x12 from the bottom up.

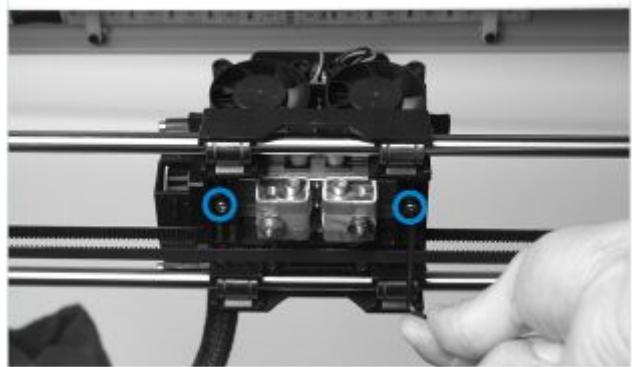

3. Install the side fan duct. To do this, find the side fan duct and attach it onto the left side of the extruder set. Secure it with the supplied M3x8 screw.

**Tip:** place the M3x12 screw through the mounting hole of the extruder seat first. Afterwards, align the extruder set and tighten.





---

## Installing Filament

1. Lock the filament in place by securing it with the filament spool holder and turning it counter-clockwise.



2. Feed the filament through the filament guide tube. Attach the guide tube onto the two filament guide tube brackets.

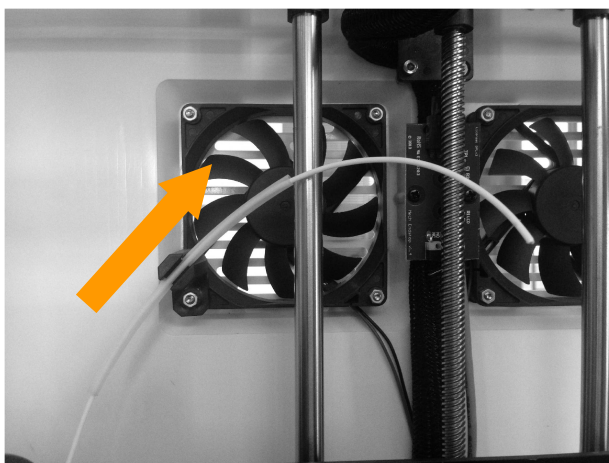

3. Stick the build sheet to the build plate after installing filament, as picture shows.



---

## Plugging in Power Cord & USB Cable

1. Locate the power cord, and plug it into the Dreamer.

**Optional:** Locate the USB cord and plug one end into the Dreamer and the other into your computer. The Dreamer supports USB 2.0.



# D. Loading/unloading Filament

Filament must pass through the extruder and into the heating block in order to be melted. In this user guide, we will demonstrate loading and unloading filament using the left side extruder.

## Loading filament:

1. Remove the lid of the Dreamer

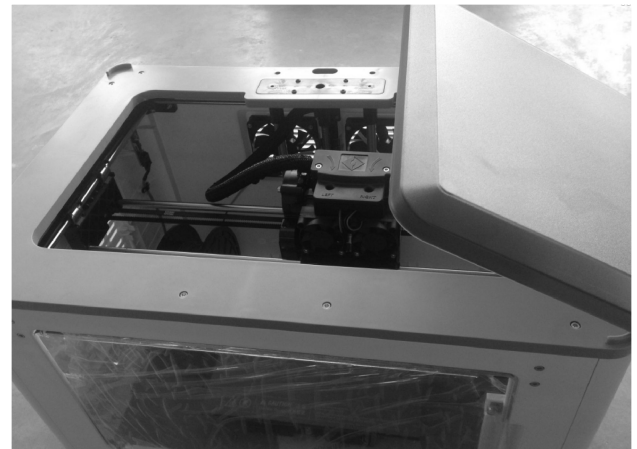

2. From the main menu, press the right icon labeled [ **Tools** ].

3. Select [ **Filament** ] and [ **Load Left** ].

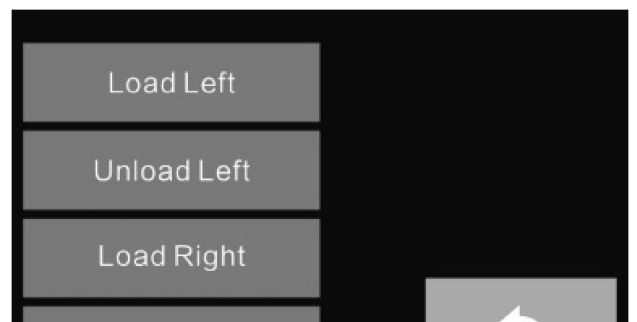
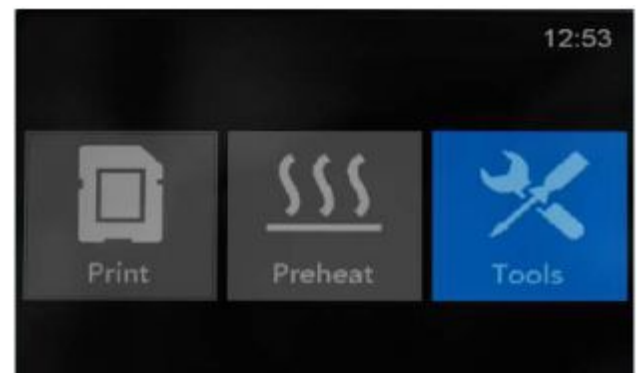

---

4. Wait for the extruder to heat up to the operating temperature. The extruder will alert you once it is at the operating temperature. Load the filament by inserting it into the extruder at an upright angle.

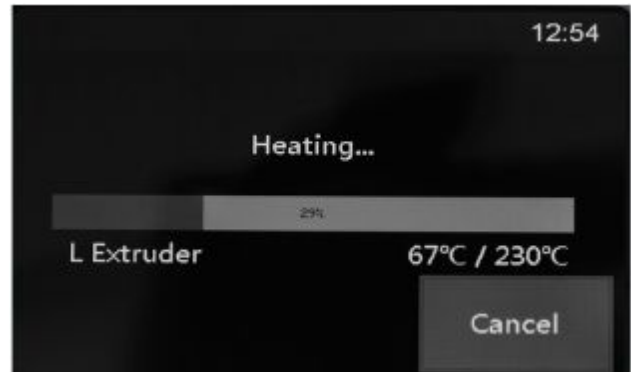

5. Filament will start to extrude out of the nozzle. Continue loading to ensure that the filament is extruding in a straight line. Refer to the troubleshooting section if the filament is extruding at an angle.

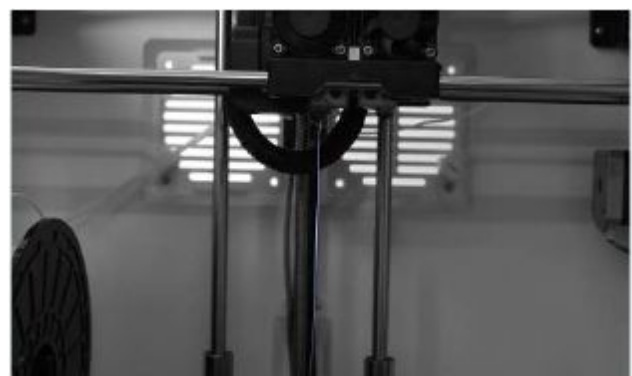
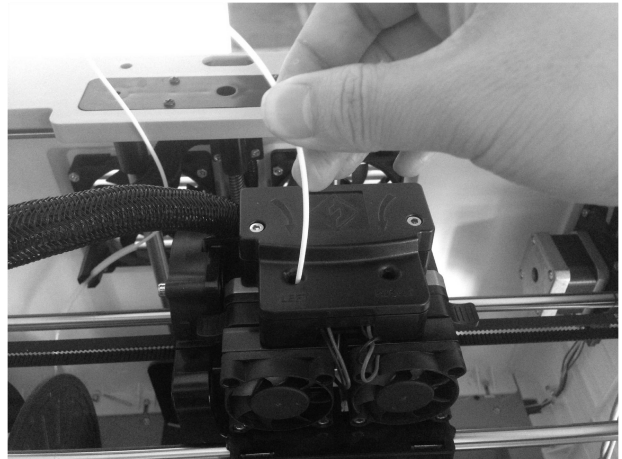

## Unloading filament:

1. Remove the lid of the Dreamer



2. From the main menu, press the right icon labeled [ **Tools** ].

3. Select [ **Filament** ] and [ **Unload Left** ].

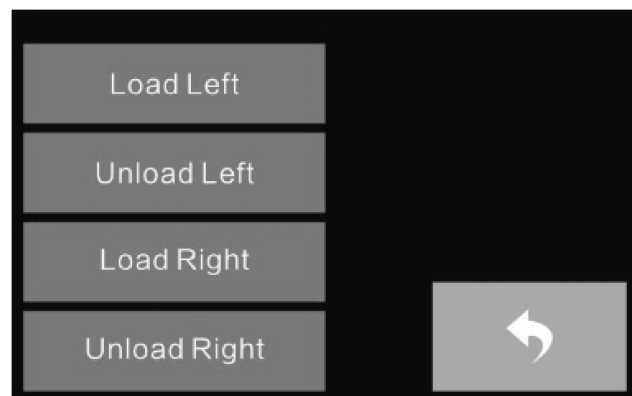
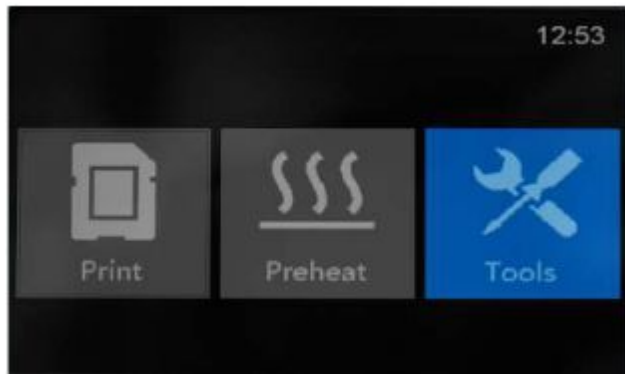

4. Wait for the extruder to heat up to the operating temperature. The extruder will alert you once it is at the operating temperature. Unload the filament by gently guiding it out of the extruder.



## E. Leveling the Build Plate

A correctly leveled build plate will almost always guarantee a quality 3D object. When printed objects have issues, the first step to diagnose is to check and double-check to make sure the build plate is leveled. A general rule of thumb is to leave a gap that is the thickness of a piece of paper. However, for printing finer objects (150 micron and lower), please use a feeler gauge to level the build plate as it requires a lesser gap between the nozzle and the build plate.

The Dreamer utilizes a three-point leveling system for its build plate. At the bottom of the build plate, there is one spring-loaded screw in the front and two in the back. Tightening the screw will create a bigger gap between the build plate and the nozzle while loosening it will create lesser gap.

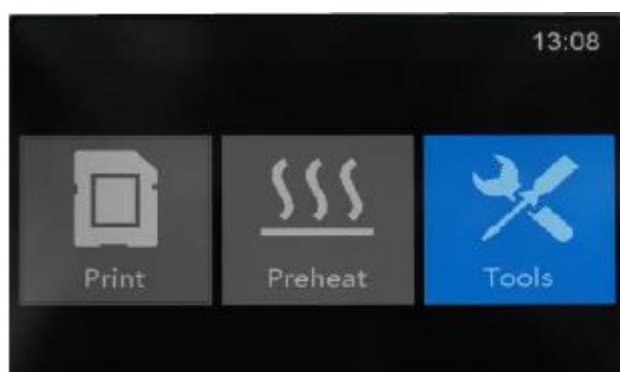

1. From the main menu, select **[Tools]** and **[Level]**. The extruder and the build plate will begin to move to the starting position.

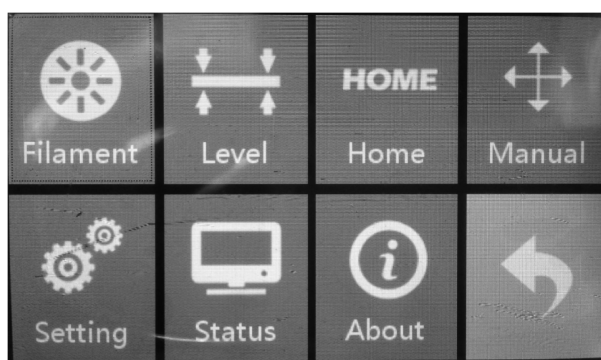

2. Take out the leveling sheet (QR-Code for leveling video can be scanned)

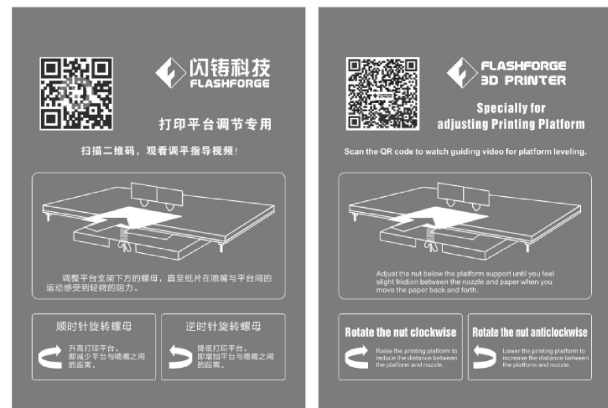

3. Once the extruder and build plate stops moving, slide the piece of paper continuously back and forth between the nozzle and the build plate. And simultaneously adjust the screw just enough so that the paper causes a slight friction.



4. Press [ NEXT ] and wait for the extruder to move to the second position. Slide the paper back and forth again, and adjust the screw to create the same amount of friction as the previous step.

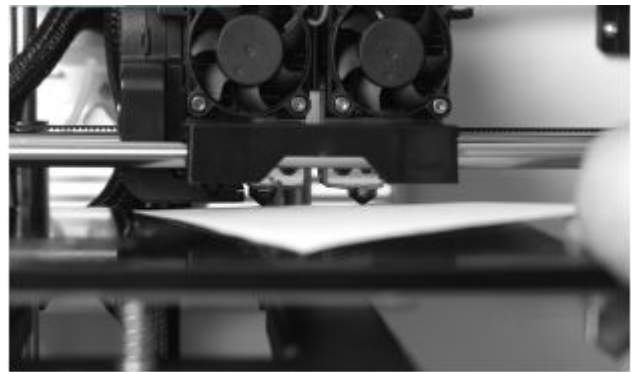

5. Press [ NEXT ] again and repeat the same leveling technique.



---

5. Press [ **NEXT** ]. The nozzle will move to the center of the build plate. Slide the paper through to make sure there is a slight friction. Slowly adjust all the screws by the same amount if there is no friction or too much friction.

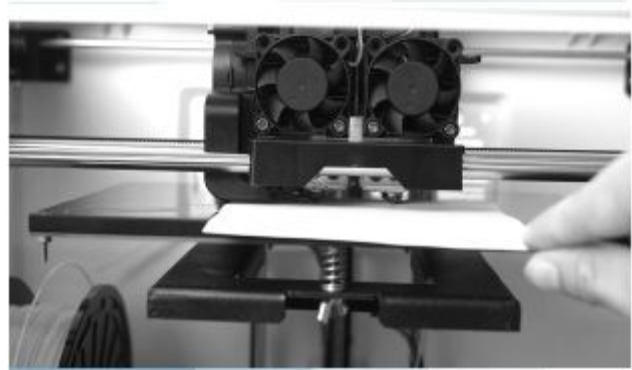

6. Press [ **FINISH** ] once you have finished this.





Chapter2.

# A THOROUGH LOOK AT THE FLASHPRINT SOFTWARE

## A. Overview of the function

## A. Overview of the function

FlashPrint is an application with advanced functions that integrates seamlessly with the Dreamer to make it print like a dream. It is an all-in-one solution, with functions such as controlling the Dreamer remotely, printing over Wi-Fi, and having separate, customizable, settings for the left and right extruders. The team at FlashForge is consistently updating FlashPrint to include additional functions that work seamlessly with the Dreamer.

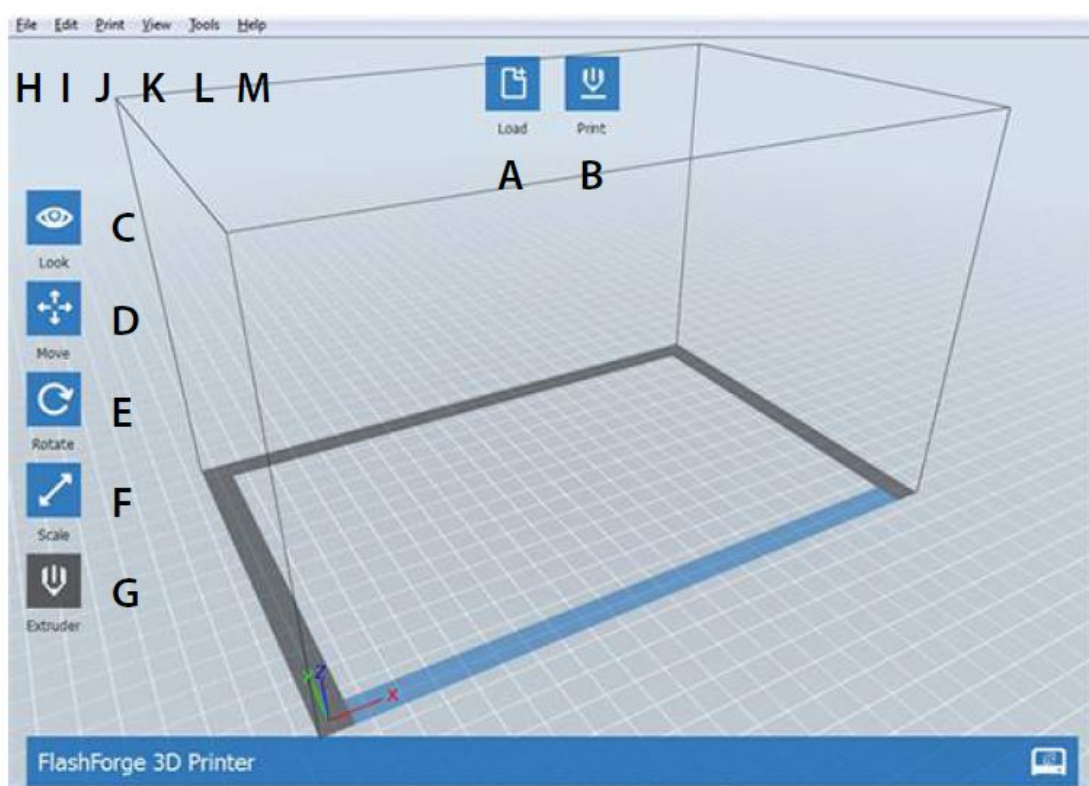

### Main Functions/Icons:

- |          |             |
|----------|-------------|
| A. Load  | E. Rotate   |
| B. Print | F. Scale    |
| C. Look  | G. Extruder |
| D. Move  |             |

### Menu Functions

- |          |         |
|----------|---------|
| H. File  | K. View |
| I. Edit  | L. Tool |
| J. Print | M. Help |

---

## Explanation of the Functions

- A. Load:** Loads an “stl” format file to FlashPrint. The object will appear on the screen after a successful load.
- B. Print:** Prints the object as it appears on the screen. Different printing methods are available (see the part on “Initial Print”). Clicking on this will prompt slicing settings where you will be able to adjust print speed, print material, and more.
- C. Look:** Allows user to view the object on the platform. Press and hold the left mouse button to pan the view. Press and hold the right mouse button to rotate the view.
- D. Move:** Allows user to move objects around the virtual build platform. The coordinates (0,0,0) indicate the middle of the platform. Changing the x, y, and z numbers will result in displacement of the object:
- **Increasing x value** = moving object to the right
  - **Decreasing x value** = moving object to the left
  
  - **Increasing y value** = moving object to the back
  - **Decreasing y value** = moving object to the front
  
  - **Increasing z value** = moving object to the up
  - **Decreasing z value** = moving object to the down

**NOTE:** Moving the object up or down (z-axis) may result in the object not being set on the platform hence fail to print. Always make sure to put the object on the platform before printing.

- **On Platform:** Brings the object to the platform and make sure it prints successfully.
- **Center:** Brings the object to the middle of the platform.
- **Reset:** Reset all the position displacement changes have been made to the object.

---

**E. Rotate:** Allows user to rotate the object respect to x, y, and z axis.

- **Reset:** Resets all the position changes that have been made to the object.

**F. Scale:** Allows user to scale the object to a different size. You can scale the object either by the actual dimension of the object or by percentage.

- **Uniform scaling:** When this option is checked, changing one of x, y and z axis values will change all three. This is to ensure the shape of the object is not affected by changing its size.

(NOTE: Unchecking this box and changing one of the axis values will result in changing the shape of the object).

- **Maximum:** Automatically scale the object to the maximum size that the printer can print.

**G. Extruder:** Allow users to choose which extruder they would like to print the object. Object that print with either extruders would show in the corresponding color.

**H. File:**

- **Load:** Loads the “stl” file to the program, the object will appear on the screen after a successful load.
- **Save Scene:** Saves the file as it appears on the screen.
- **Example:** Sample 3D designs included in FlashPrint that users can print from.
- **Recent Files:** Files that are currently loaded will be shown here.
- **Preference:**
  - **Language:** Allows users to choose language for the software. Languages that are available now are English, Chinese Simplify, Chinese Traditional, and Japanese.
  - **Checks for update after start:** This option allows FlashPrint to check for update. If an update is available, it will prompt users to update the software version.
- **Quit:** Exit the software.

---

## I. Edit:

- **Undo:** Undo the last step of modification to the file.
- **Redo:** Redo an “Undo.”
- **Select All:** Selects all the objects on the build plate.
- **Duplicate:** Copy and paste the selected object.
- **Delete:** Delete the selected object.

## J. Print:

- **Connect:** Allow users to connect the Dreamer to FlashPrint by either USB or Wi-Fi.
- **Disconnect:** Disconnects a connection. This option will be grayed out when there is no connection established.
- **Print:** Prints the object as it appears on the platform.
  - **Preview:** When this box is checked, a summary will be shown after slicing. It shows the length the filament will be used, the estimated time, and the total layers (on the left) for the print job. User can also scroll the bar on the left hand side of the screen to see the partial object by layers.
  - **Print When Slice Done:** Printing will automatically start after FlashPrint finishes slicing the model.
  - **Slice Engine:** The engine used to slice the object. Slicing engines currently available are Slic3r and Skeinforge. Certain options/functions are only available for the specific slicing engine.
  - **Machine Type:** Choose the number of extruders to print with. Selecting FlashForge Dreamer will print with both extruders while FlashForge Dreamer Single will print with one extruder. (NOTE:When choosing FlashForge Dreamer Single, make sure that the extruder you selected has filament pre-loaded.)
  - **Material Right:** Choose the material that will be used for the right extruder.

- 
- *Material Left*: Choose the material that will be used for the left extruder.
  - *Supports*: Enable/disable support for the object. (**Note**: Excessive overhang usually requires support to print successfully.)
  - **Resolution**: Presets values for layer thickness, infill, and speed. These values can be modified at “**More Options**.”
  - **Wall** (Available for Slic3r): Builds a wall around the object with the same height.
  - **Raft** (Available for Skeinforge): Builds a raft under the 3D object.
  - **Skirt**: Builds a single layer wall/outline around the object.
  - **More Options**:
    - *Layers*
    - **Layer Height**: Smaller number means higher resolution. typical values are between 0.1 and 0.5 (100 to 500 microns). Use 0.5 for fast prototypes and 0.1 for fine details.
    - **First Layer Height (Available for Slic3r)**: Enter the layer height of the first layer. A small value of layer height requires a more precise leveling in order for the filament to stick. Sometimes it is difficult to accomplish. By adjusting the first layer height, it allows user to print a fine object with a higher success rate.
    - **Number of Shells**: Enter the number of layers that surrounding the object. Typical values are between 1 and 5.
    - *Infill*
    - **Fill Density**: Enter the density value of the object. 0% means completely hollow and 100% means completely solid. Typical values are between 3% and 50%.
    - **Fill Pattern**: Select the pattern for printing the infill. Available patterns are line, rectangle, and hexagon.

- 
- *Speed*
  - **Print Speed:** Enter a print speed for printing the main object. Typical values are between 30mm/s and 120mm/s.
  - **Support Print Speed (Slic3r):** Enter a print speed for printing support. Typical values are between 30mm/s and 120mm/s.
  - **Travel Speed:** Enter a speed for the extruder travel when it is not extruding filament. Typical values are between 30mm/s and 120mm/s.
  
  - *Temp*
  - **Right Extruder:** Enter a print temperature for the right extruder. Typical values are between 180°C and 200°C for PLA, and 200°C and 240°C for ABS.  
**Note:** Different colors may melt at different temperatures. It is recommended to print with FlashForge or its recommended filament brands as sub-par quality filaments will clog and damage the extruder.
  - **Left Extruder:** Enter a print temperature for the left extruder.  
**Note:** When printing using only one extruder, settings for the other extruder will not matter. For example, if printing only with left extruder and both extruders are set to a temperature of 220°C, the right extruder will not heat up at all when actually printing.
  - **Platform:** Enter the platform temperature when printing. Typical values are 50°C for PLA and 110°C for ABS.
  
  - *Other*
  - **Turn Fan On:** There is a cooling fan attached to the left hand side of the extruder set. This fan is for cooling down PLA filament after extrusion. Turning on the fan is highly recommended for PLA prints.
    - **Auto:** if this option is selected, the fan will turn on when PLA is selected at “Material Right/Left.”
  - **Overhang Threshold:** When printing with support, enter a number between 0° to 90° for the slicing engine to recognize the support area. The degree values are measure from the

---

horizontal to the tangent line of the curve.

- **Exterior Support Only (Available for Skeinforge):** When this option is checked, only exterior support will be built. For example, when printing letter “O,” supports will be considered as interior support and when printing a letter “F,” supports will be consider exterior support.
- **Restore Defaults:** Reset all the changes to system default.
- *Save Configuration:* Save all the settings on this page. When slice another object, it will load these saved settings.

**K. View:** Gives users 7 different directions to view the object.

- *Show Model Outline:* Displays an outline of all the objects.
- *Show Steep Overhang:* Displays steep overhang that possibly needs support when printing.

**L. Tools** (only available when Dreamer is connected to FlashPrint via USB)

- *Control Panel*
- **Homing**
- *Homing X:* Move the extruder set to the right side until it triggers the x-axis sensor and stop.
- *Homing Y:* Move the extruder to the back until it triggers the y-axis sensor and stop.
- *Homing Z:* Move the build plate up until it triggers the z-axis sensor and stop.
- *Homing All:* Perform homing for x, y, and z.
  
- **Jog Mode**
- Move the extruders and the platform to the direction of the arrow buttons indicated. Pressing the button once will move the extruders/platform by the increment selected at the drop-down menu.
- *Stop:* When the extruders/platform is moving, this button will stop this movement immediately.



- 
- *Jog Mode*: Select from the drop down menu for increment of each move.
    - *Center X*: Same as “Homing X.”
    - *Center Y*: Same as “Homing Y.”
    - *Center Z*: Same as “Homing Z.”
  - *Make Current Position Zero*: Set the current position of the extruders and the platform as (0, 0, 0). (**NOTE**: X, Y, and Z boxes are for display purposes. Changing the value in the boxes will not affect anything.)
  - *X/Y Speed*: Controls how fast the extruders will move when performing the above movements.
  - *Z Speed*: Controls how fast the platform will move when performing the above movements.
  
  - **End-Stop Switch**
    - *X Maximum Status*: Displays “Open” when the extruder is not at the maximum X position. Displays “Triggered” when the extruder reaches the maximum x position.
    - *Y Maximum Status*: Displays “Open” when the extruder is not at the maximum Y position. Displays “Triggered” when the extruder reaches the maximum Y position.
    - *Z Minimum Status*: Displays “Open” when the extruder is not at the minimum z position. Displays “Triggered” when the extruder reaches the minimum Z position.
  
  - **Fan Controls**
    - *Open*: Turn on the side fan located at the left of the extruders.
    - *Close*: Turn off the side fan located at the left of the extruders.
  
  - **Stepper Motor Controls**
    - *Enable*: Unlock the motor to be controlled manually.
    - *Disable*: Lock the motor so it does not allow any movement.
  
  - **LED Color**: Change the LED color of the Dreamer.

---

- **MK 8 Left Plastic Extruder**

- *Motor Speed (RPM)*: Select a speed between 2 to 10 RPM for when performing “Motor Control.”
- *Extrude Duration*: Select duration for the motor to move when performing “Motor Control.”

- **Motor Control**

- *Forward*: Trigger the motor to spin clockwise as “Load Filament.”
- *Reverse*: Trigger the motor to spin counter-clockwise as “Unload Filament.”
- *Stop*: Stop any movement of the motor.

- **MK8 Right Plastic Extruder**

- \*Same as MK8 Left Plastic Extruder.

**NOTE:** When on “Motor Control”, the right extruder spins counterclockwise for “Forward” and clockwise for “Reverse”.

- **Extruder Temperature Controls**

- *MK 8 Left Target*: Enter a temperature in Celsius for the left extruder. Click [ **Apply** ] to apply this setting.
- *MK 8 Left Current*: Shows the current temperature for the left extruder.
- *MK 8 Right Target*: Enter a temperature in Celsius for the right extruder. Click [ **Apply** ] to apply this setting.
- *MK 8 Right Current*: Shows the current temperature for the right extruder.
- *Platform Target*: Enter a temperature in Celsius for the platform. Click [ **Apply** ] to apply this setting.
- *Platform Current*: Shows the current temperature for the platform.

**NOTE:** There are “heating elements” embedded in the extruders and platform. Applying any temperature lower than the current temperature would not cool down the extruders or platform.

- 
- **Temperature Chart:** After applying temperature target, this chart will show the temperature changes over time.
  - **Update Firmware:** Checks and updates Dreamer to the latest firmware version. The Dreamer must be connected via USB in order to update.
  - *On Board Preferences:*
    - **Machine Name:** Change the name of the Dreamer.
    - **Extruder:** Select the number of extruder of your printer.
    - **Extruder Distance:** Specify the distance of the extruders. Default values are X: 34.00mm, and Y: 0.0mm.
  - *Machine Information:*

Displays machine information such as machine type, machine name, firmware version, and more.

## M.Help

- **Help Contents**
- **Check for updates:** Checks if there is a newer version of FlashPrint available.
- **Report A Problem**
- **About:** Shows the current version of FlashPrint.

# CHAPTER 3

# MAKING YOUR FIRST PRINT

**A. Overview**

**B. Single & dual-extrusion print**

**C. Methods of printing.**

# A. Overview

---

This chapter will provide a step-by-step guide on turning a 3D model into a physical reality. Before proceeding, it is recommended that you go over prior chapters on loading/unloading filament, leveling the build plate, and the functions and capabilities of FlashPrint.

There are two modes of printing: single-extrusion and dual-extrusion. With single extrusion, you can choose the print head to use for making the print. Dual extrusion is useful if you want to print dual colors or complex models that require supporting material.

There are three connection methods in order to print using the Dreamer. All methods, which include USB, SD card, and Wi-Fi are covered in this chapter.

## B. Single & dual-extrusion print

---

### Single-Extrusion Print

1. Open **FlashPrint** by double-clicking on the icon.
2. Click on [ **Load** ] and choose an .stl file from hard drive.
3. The object will then be shown on the screen.
4. Click on the object and then click on [ **Extruder** ], select [ **Use left extruder** ]. \*Left extruder will be used for illustration purposes.
5. Now the 3D model is ready to be created. Proceed to part C of this chapter (page 47) to select your connectivity method for printing.

### Dual-Extrusion Print

1. Open **FlashPrint** by double-clicking on the icon.
2. Press [ **Load** ] and choose an .stl file from hard drive.
3. The object will then be shown on the screen.
4. Press [ **Load** ] and choose another (or the same) file from hard drive.
5. Click on the object and then click on [ **Extruder** ], select [ **Use left extruder** ].

**NOTE:** one object is turned to green, that indicates it will be print wit the left extruder.

6. Now the 3D model is ready to be created. Proceed to part C to select your connectivity method for printing.

# C. Methods of printing

---

## Printing from USB

1. Connect Dreamer to the computer using the included USB 2.0 cable.
2. Turn on the Dreamer. Make sure the build plate is leveled and filament is loaded to the left extruder. Please refer to page 22 for leveling the build plate and pages 19 and 21 for loading and unloading filament.
3. Select [ **Print** ] from menu bar, then select [ **Connect** ].
4. Click on [ **Rescan** ], then [ **Connect** ].
5. Now the printer is connected with FlashPrint. A status box at the lower right corner will show the temperature of both extruders and the platform.
6. Press [ **Print** ] icon, and a printing options screen will appear. Make sure that “**ABS**” is selected under **Material Left**. Advanced settings can be set under [ **More Options** ] icon. Check the box “**Print When Slice Done**” and click [ **OK** ].
7. Save the file at any location, and the object will start slicing
8. After the object is done slicing, it will automatically upload the gcode to the Dreamer.
9. After the gcode is done uploading, the printer will go into a preheat phase . The Dreamer will begin printing once it has finished preheating.

---

## Printing from SD Card

1. Press [ **Print** ], and a printing options screen will show up.
2. Make sure that the “**Material Left**” is selected as “**ABS**.” Advanced settings can be set under [ **More Options** ] icon.
3. Click [ **OK** ], and save the gcode file in the SD card.
4. FlashPrint will begin slicing the 3D model.
5. After the object is done slicing, take the SD card from the computer. Insert it into the SD card slot on the Dreamer.
6. Turn on the Dreamer. Make sure the build plate is leveled (page 22) and filament is loaded on the left extruder (page 19).
7. Press [ **Print** ] and then press the middle **SD Card** icon.
8. A list of file(s) will show up, press the file that you would like to print, then press [ **Yes** ].
9. The printer will now enter preheating phase and will start printing once it finishes preheating



---

## Printing from Wi-Fi

1. Turn on Dreamer. Make sure the build plate is leveled (page 22) and filament is loaded on the left extruder (page 19).
2. Turn on Wi-Fi on the Dreamer. To do this, press [ **Tools** ], [ **Setting** ], [ **WIFI** ], and [ **WIFI ON**].

3. A connection called “**USR-WIFI232-G2**” can be found on the list of available networks. Connect to this network.



4. Open your Internet browser. Type in “**10.10.100.254**” and hit [ **Enter** ] on your keyboard. Enter the username and password to login. The default *username* and *password* are both “**admin**.” The control panel will appear after a successful login.



5. Click on [ **Work Mode** ] and choose “**AP+STA mode**” and save it.

6. Click on [ **STA Setting** ], select a working network, enter the corresponding password and save.



7. Restart the interface, close the page, turn off the Dreamer, disconnect from the network, and wait for 10 seconds.

8. Turn the Dreamer back on and connect to the Dreamer network. In FlashPrint, choose [ **Print** ] from menu and select [ **Connect** ].

9. Under “**Connection Mode**”, select Wi-Fi, and enter the “**IP Address, Port**” as shown on printer LCD screen. Then, click [ **Connect** ].

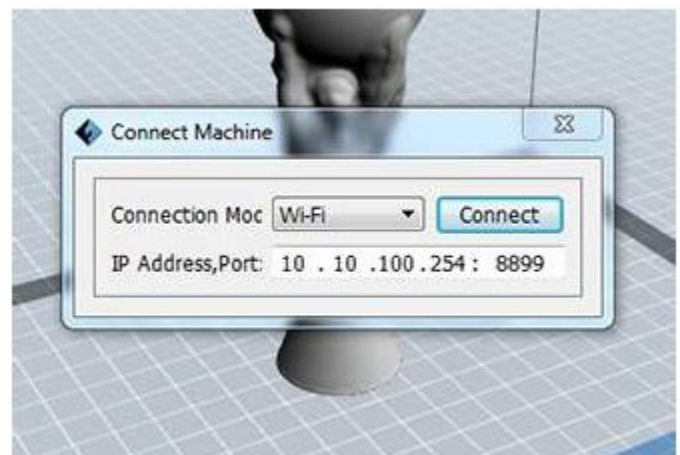

- 
10. Now the Dreamer is connected with FlashPrint. A status box at the lower right corner will show the temperature of both extruders and the Platform.
  11. In FlashPrint, click [ **Print** ]. A printing options screen will appear. Make sure that “**ABS**” is selected under “**Material Left**.” Advanced settings can be set by clicking on [ **More Options** ].
  12. Check the box of “**Print When Slice Done**,” and hit [ **OK** ].
  13. Save the file at any location, and the object will start slicing.
  14. After the object is done slicing, it will automatically upload the gcode to the Dreamer.
  15. After the gcode is done uploading, the printer will go into a preheat phase. The Dreamer will start printing once preheating is finished.

**NOTE: Printing from SD card is unavailable when WIFI is ON.**

### **Printing with Support**

1. If the 3D model has excessive over-hang, then support will be needed.
2. In the **Slice** options screen, select from “**Supports**” the left or right extruder.
3. Click [ **OK** ] to begin slicing.

# CHAPTER 4

# ADDITIONAL

# INFORMATION

**A. Getting support**

**B. Appendix**

## A. Getting support

---

Our team of knowledgeable staff is on standby and ready to help you overcome any challenges you may have with your Dreamer. If your issue or question is not covered in the user manual, you can check our knowledge base or contact us by e-mail or phone. We also have a very active FlashForge community group on Google with a wealth of information and very helpful members.

There are solutions and instructions to common issues that can be found in our knowledge base. Have a look first as most basic questions are answered there.

<http://www.ff3dp.com>

The FlashForge Google Group is a community forum made up of fellow FlashForge users who share tips and tricks and help each other in overcoming challenges with 3D printing. The forum can be accessed at the following link:

<https://groups.google.com/d/forum/flashforge>

The FlashForge support team can be reached by e-mail or phone between the hours of 8:00 a.m. to 5:00 p.m. PST Monday through Saturday. In case you contact us during after-hours, your inquiry will be answered the following business day.

E-Mail: [support@sz3dp.com](mailto:support@sz3dp.com)

Tel: **0579-82273989**

Address: **No.518 Xiangyuan Road, Jinhua, China.**

**\*When contacting support, please have your serial number ready.  
The serial number is a bar code on the back of your Dreamer**

## B. Appendix

---

### Parameter table

Name	Dreamer
Extruder Number	2
Technique	Fused Deposition Modeling (FDM)
Screen	3.5'' color IPS Touch Screen
Build Size	230×150×140mm
Layer Thickness	0.1 - 0.5mm
Build Precision	±0.2mm
Located Precision	Z axis 0.0025mm; XY axis 0.011mm
Filament Diameter	1.75mm
Nozzle Diameter	0.4mm
Current Speed	24CC/Hour
software	FlashPrint
Support Formats	stl、obj
OS	Windows Mac OS
Printer Size	485×400×335mm
Weight	11Kg
Input Voltage	100-240V, 50-60Hz, 300W
Data Transmission	USB、SD card、wifi